

Conveyor accessories

Chain drive sprocket

HKU815	Plastic sprockets	34
HKS815	Plastic sprockets	34
HNS815	Plastic sprockets	34
HKS821	Plastic sprockets	34
HKU820	Plastic sprockets	35
HKS820	Plastic sprockets	35
HNS820	Plastic sprockets	35
HKU821	Plastic sprockets	35
HKS880	Plastic sprockets	36
HN880	Plastic sprockets	36
HNS880	Plastic sprockets	36
HKU880	Plastic sprockets	36
HNS880S	Sprockets	37
HKU882	Plastic sprockets	37
HKS882	Plastic sprockets	37
HN882	Plastic sprockets	38
HNS882	Plastic sprockets	38
HKU881	Plastic sprockets	38
KNS881	Plastic sprockets	38

Knuckle chain sprockets

HKU1700	Plastic sprockets	39
HN1700	Plastic sprockets	39
HKUA600	Plastic sprockets	39
HKUA1400	Plastic sprockets	39

Chain passive sprocket

HXT820	Straight chain passive sprocket	40
HXT820-1	Straight chain passive sprocket	40
HXT880TAB	Plastic passive sprocket	40
HXS882	Plastic passive sprocket	40
HXK882	Plastic passive sprocket	40
HXS880	Plastic passive sprocket	41
HXK880	Plastic passive sprocket	41
HXS881	Plastic passive sprocket	41
HXK881	Plastic passive sprocket	41
H1100	Plastic sprockets	42
H1100	Plastic sprockets	42
H3110	Plastic sprockets	42
H5935\H5936	Plastic sprockets	42
H2200	Plastic sprockets	42

H3110	Plastic sprockets	43
H1600	Plastic sprockets	43
HJ2075	Nozzles	43
HJ2076	Nozzles	43
HJ20751	Nozzles	43

Chain sprockets

H1000	Chain sprockets	44
H5935	Chain sprockets	44
H900	Chain sprockets	44

Chain finger plate

H100T16	Finger transfer plates	45
H1600RRT7-1	Finger transfer plates	45
H900	Finger transfer plates	45
H3110T24	Finger transfer plates	45
H4707ST12	Finger transfer plates	45
H2004T24	Finger transfer plates	45
H4707R12	Finger transfer plates	45
H5997T12	Finger transfer plates	45
H4803T32	Finger transfer plates	45
H5937T15	Finger transfer plates	45
H2037T28	Finger transfer plates	45

Link code

H174	Cross clamp A	46
H340	Cross clamp B	46
H341	Clamp A	46
H339	Clamp A	46
H587A	Cross Clamp for Circular	47
H587B	Cross clamp for square	47
H518	Control contact lever for sensor	47
H343D	Pipe plug	47
H343E	Square plug	47

Conveyor accessories

Guide rail bracket

H257	Guide rail bracket A	48
H107	Guide rail bracket C	48
H617	Guide rail bracket D	48

Guide rail gripper

H182A	Thread knob	49
H185A	Thread knob	49
H183	Thread knob	49
H185	Thread knob	50
H71	Rail clamp	50
H303	Handle T	50

Guard rail bracket accessories

H185	Thread knob	51
H181	Screw	51
H256	Head for bracket	51
H225/H359	Round screw	52
H193	Guard rail bracket	52
H142	Bracket spacer	52
H159-12	Clamp for round tube	53
H437-12	Clamp for round	53
H82-12	Clamp for square	53
H210	Square single clamp	53
H2011	Double clamp	54
HG508A	Roller bearing	54
F268	Joinball	54
HJ200	Leveling feet	54

Roller guard rail

H580-32	Roller side guard rail	55
H580-64	Roller side guard rail	55
H128-47	Roller guard rail	56
H128-73	Roller guard rail	56
H64-0	Dynamic guard rail	56
H128-99	Roller guard rail	57
H128-125	Roller guard rail	57

Guard rail accessory

H363-1	Ball bearing	57
H363-3	Ball bearing	57

Plastic chain accessories

H567	Ball bearing transfer	58
H569	Ball bearing transfer	58
H568	Ball bearing transfer	58
H1600	Single radius roller guide	58

Guard rail

H537-8	Steel guard rail	59
H537-10	Steel guard rail	59
H219	D Type guard rail A	59
H539	C Type guard rail50	59
H538-1	C Type guard rail60	60
H538-2	E Type aluminum wear strip	60
Hg051	Guard bar A	60
Hg052	Guard bar B	60

Wear strip

H368	Stainless steel wear strip	61
H366N	T Type wear strip	61
H367N	Flat wear strip	61
H367NL	L Type wear strip	61
H550	Inlet Guide	62
H552	Inlet Guide	62
H371	Mounting blocks	62
HDS001	Flat wear strip	63
HDS002	Flat wear strip	63
HDS003	Flat wear strip	63
HDS004	Flat wear strip	63
HDS005	Flat wear strip	63
HDS006	L Type wear strip	63
HDS007	Z Type wear strip	63
HDS008	Z Type wear strip	63
HDS009	L Type wear strip	63
HDS010	K Type wear strip	63
HDS011	K Type wear strip	63
HDS012	K Type wear strip	63
HDS013	U Type wear strip	63
HDS014	Cover wear strip	63
HDS015	Cover wear strip	63
HDS016	Cover wear strip	63
HDS017	Type L wear strip	63
HDS018	Guide rail	63
HDS019	A Pommel guard bar	64
HDS020	A Pommel guard bar	64
HDS021	D Type B1 guard bar	64
HDS022	C Type guard bar	64
HDS023	T Type wear strip	64
HDS024	Tt Type wear strip	64
HDS025	U Type wear strip	64

Conveyor accessories

HDS026	G Type buckle	64	HDS069	T Type wear strip	66
HDS027	Chain bracket	64	HDS070	Flat wear strip	66
HDS028	Chain bracket	64	HDS071	U Type wear strip	66
HDS029	Chain bracket	64	HDS072	L Type wear strip	66
HDS030	Bushing guard bar	64	HDS073	H-shaped wear strip	66
HDS031	Low hurdles	64	HDS074	Dumbbell-shaped guard bar	66
HDS032	High hurdles(bilateral)	64	HDS075	Cover type strip	66
HDS033	High hurdles(unilateral)	64	HDS076	U Type wear strip	66
HDS034	Middle hurdles	64	HDS077	U Type wire strip	66
HDS035	Flat wear strip	65	HDS078	U Type wire strip	66
HDS036	L Type wear strip	65	HDS080	D Type guard bar(stainless steel)	67
HDS039	Large side moulding	65	HDS081	D Type guard bar(stainless steel)	67
HDS040	Middle side moulding	65	HDS082	Flat track pad	67
HDS041	Small side moulding	65	HDS083	H-shaped steel	67
HDS042	U Type buckle	65	HDS084	H-shaped steel	67
HDS043	L Type wear strip	65	HDS085	Aluminum alloy	67
HDS044	T Type wear strip	65	HDS086	C Type guard bar(Aluminum alloy)	67
HDS045	T Type wear strip	65	HDS087	Wear strip(with stainless steel)	67
HDS049	Flat wear strip	65	HDS088	L type wear strip	67
HDS050	T Type wear strip	65	HDS089	Cover type wear strip	67
HDS051	Flat wear strip	65	HDS090	Guide rail(with steel)	67
HDS052	Flat wear strip	65	HDS091	L type wear strip	67
HDS053	Flat wear strip	65	HDS092	C type guide rail(self-matching)	67
HDS054	Flat wear strip	65	HDS094	U Type wear strip	67
HDS055	K Type wear strip	65	HDS095	Dumbbell-shaped guard bar	67
HDS056	K Type wear strip	65	HDS096	U Type buckle	68
HDS057	Flat wear strip	65	HDS097	U type strip ABS	68
HDS058	Type L cover strip	66	HDS098	T type guard bar	68
HDS060	K Type wear strip	66	HDS099	Net chain core	68
HDS061	K Type wear strip	66	HDS100	High guard bar(unilateral)	68
HDS065	Rocker wear strip	66	HDS101	Aluminum alloy flat wear strip	68
HDS066	T Type wear strip	66	HDS102	Aluminum alloy flat wear strip	68
HDS067	Aluminum alloy guard bar	66	HDS103	C Type steel	68
HDS068	T Type wear strip	66			

Conveyor accessories

HDS400	U-shaped buckle	68	HDS436	Flat track pad	70
HDS401	Wear strip	68	HDS437	Flat track pad	70
HDS402	T type wear strip	68	HDS438	Flat track pad	70
HDS403	H-shaped wear strip	68	HDS439	Pommel groove wear strip	70
HDS404	U Type wear strip	68	HDS440	Groove wear strip	70
HDS405	Flat wear strip	68	HDS441	T type wear strip	70
HDS406	L Type wear strip	68	HDS442	Groove wear strip	70
HDS407	B type low guard bar	68	HDS443	Buckle	70
HDS408	U Type wear strip	68	HDS444	H-shaped wear strip	70
HDS409	Tu Type wear strip	69	HDS445	Cover type wear strip	70
HDS412	Wear strip	69	HDS446	K type wear strip	70
HDS413	Flat wear strip	69	HDS447	L type wear strip	71
HDS414	Wear strip	69	HDS448	Z type wear strip	71
HDS415	Cover type wear strip	69	HDS449	Long guard bar	71
HDS416	Guide rail	69	HDS450	Double T-shaped wear strip	71
HDS417	T type wear strip	69	HDS451	F type wear strip	71
HDS418	Cover type wear strip	69	HDS452	Flat wear strip	71
HDS419	H-shaped wear strip	69	HDS453	Flat wear strip	71
HDS420	K type wear strip	69	HDS454	T type wear strip	71
HDS421	Wear strip	69	HDS455	U type wear strip	71
HDS422	Arrow-shaped wear strip	69	HDS456	Flat wear strip	71
HDS423	Wear strip	69	HDS458	Flat wear strip	71
HDS424	U type wear strip	69	HDS459	Flat wear strip	71
HDS425	Flat wear strip	69	HDS460	U type wear strip	71
HDS426	Flat wear strip	69	HDS461	U type wear strip	71
HDS427	Bushing guard bar	69	HDS462	Flat wear strip	71
HDS428	K type wear strip	70	HDS463	Chain bracket	72
HDS429	Support wear strip	70	HDS457	Double T-shaped wear strip	72
HDS430	Groove wear strip	70	HDS464	K type wear strip	72
HDS431	Chain strip	70	HDS465	U type wear strip	72
HDS432	Groove wear strip	70	HDS466	Mountain-shaped wear strip	72
HDS433	T type track pad	70	HDS467	U Type wear strip	72
HDS434	Flat track pad	70	HDS468	Cover type wear strip	72
HDS435	T type track pad	70	HDS469	Double T-shaped wear strip	72

Conveyor accessories

HDS470	Groove wear strip	72
HDS471	Wearing strips for Bottle holder	72
HDS472	Square wear strip	72
HDS473	Flat wear strip	72
HDS474	Bevel guard bar	72
HDS475	U Type wear strip	72
HDS476	L Type guard rail	72

Curved guide rail、straight guide rail

HNC880 HNC882	Curved track for H880TAB H882TAB series chain	73
HNC881M	Magnetic curved guide rail	73
H1C880BO	82 small guide rail	74
HNC880TAB	Curved guide rail	74
HNC1873	Curved guide rail	74
H1CBP882TAB	Curved guide rail	74
HNC882TAB	Curved guide rail	74
HT880TAB	Straight guide rail	75
HT882TAB	Straight guide rail	75

Wheel fitting

H73	Cylindrical roller	76
H126	Cylindrical roller	76
H125	Cylindrical roller	76
H11	Supporting wheels	76
H556	Cylindrical roller	76

Support head accessories

H198	B Support head	77
H280	A Support head	77
H199	Side support head	77
H137	T-shaped connecting joints	77
H154	Support base	78
H189	T-shaped support base I	78
H277	T-shaped support base V	78
H119	Shelf bracket	79
H615	Arc-shaped shelf bracket	79
H618	Pipe support base	79
H619	T-shaped pipe support base	80
H180	Round tubes	80
H224	Square tubes	80

Leveling feet

H98	Small leveling feet	81
H98S	Small leveling feet	81
H172	Middle leveling feet	81
H172S	Middle leveling feet	81
H133	Large leveling feet	81

H133S	Large leveling feet	81
H169	Large leveling feet	82
H98D	70 Leveling feet	82
H133D	100 Leveling feet	82
H169D	125 Leveling feet	82
H200D	200 Leveling feet	82

Accessories

Hg0034	1 HG0035	2Connection parts	83	
H220-1	光电镜安装座	H220-2光电镜安装盘	Clamp for reflector	83
H212 T	HU212V	T type chuck/V type chuck	83	
HG0046	Connecting Joints		83	
HT01422	Half of the gasket		83	
HL21	Hopper		84	
HL21-C	Hopper chain		84	
HXJ1-10-5	Square bearing pedestal		85	
H338-0	Drip tray		85	
H338	H336	Supporting clamp	85	
H226	吊钩		85	

Machine accessories

HS3633	Small hinge	86
HS3634	Large hinge	86
HS3635	Small hinge	86
H59	Door lock	86
H121	Small handle	86
H122	Large handle	86



Driving Sprocket

HKU815

Plastic sprockets

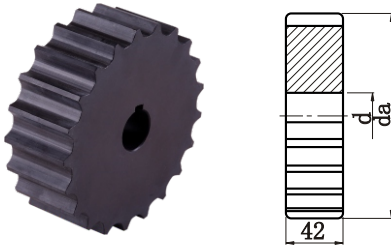

Unit:mm

Chain code	Tooth number Z	Excircle diameter da	Center bore	
			d-Metric	d-Inch
HKU815-T17R ...	17	105	25 30 35 40 45	1" 1-1/4" 1-1/2"
HKU815-T19R ...	19	117	25 30 35 40 45	1" 1-1/4" 1-1/2"
HKU815-T21R ...	21	129	25 30 35 40 45	1" 1-1/4" 1-1/2"
HKU815-T23R ...	23	142	25 30 35 40 45	1" 1-1/4" 1-1/2"
HKU815-T25R ...	25	154	25 30 35 40 45	1" 1-1/4" 1-1/2"
HKU815-T27R ...	27	166	25 30 35 40 45	1" 1-1/4" 1-1/2"

Note: 1.Sprocket is used to HS815, HS815Z, HS811M chain
2.Sprocket material: NYLON

HKS815

Plastic sprockets

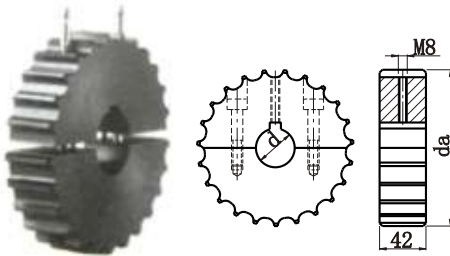

Unit:mm

Chain code	Tooth number Z	Excircle diameter da	Center bore	
			d- Metric	d- Inch
HKS815-T17R ...	17	105	25 30 35 40 45	1" 1-1/4" 1-1/2"
HKS815-T19R ...	19	117	25 30 35 40 45	1" 1-1/4" 1-1/2"
HKS815-T21R ...	21	129	25 30 35 40 45	1" 1-1/4" 1-1/2"
HKS815-T23R ...	23	142	25 30 35 40 45	1" 1-1/4" 1-1/2"
HKS815-T25R ...	25	154	25 30 35 40 45	1" 1-1/4" 1-1/2"
HKS815-T27R ...	27	166	25 30 35 40 45	1" 1-1/4" 1-1/2"

Note: 1.Sprocket is used to HS815, HS815Z, HS811M chain
2.Sprocket material: NYLON

HNS815

Plastic sprockets

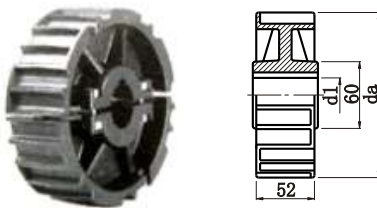

Unit:mm

Chain code	Tooth number Z	Excircle diameter da	Center bore	
			d-Metric	d-Inch
HNS815-T21R ...	21	129	25 30 35 40 45	1" 1-1/4" 1-1/2"
HNS815-T23R ...	23	142	25 30 35 40 45	1" 1-1/4" 1-1/2"
HNS815-T25R ...	25	154	25 30 35 40 45	1" 1-1/4" 1-1/2"

Note: 1.Sprocket is used to HS815, HS815Z, HS811M chain
2.Sprocket material: NYLON

HKS821

Plastic sprockets

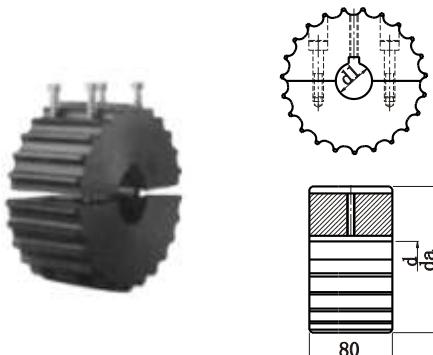

Unit:mm

Chain code	Tooth number Z	Excircle diameter da	Center bore	
			d-Metric	d-Inch
HKS821-T21R ...	21	129	25 30 35 40 45	1" 1-1/4" 1-1/2"
HKS821-T23R ...	23	142	25 30 35 40 45	1" 1-1/4" 1-1/2"
HKS821-T25R ...	25	154	25 30 35 40 45	1" 1-1/4" 1-1/2"

Note: 1.Sprocket is used to HS815, HS815Z, HS811M chain
2.Sprocket material: NYLON

HKU820

Plastic sprockets

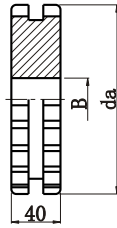

Unit:mm

Chain code	Tooth number Z	Excircle diameter da	Center bore		
			d-Metric	d-Inch	d-Inch
HKU820-T17R ...	17	105	25 30 35 40 45	1" 1-1/4"	1-1/2"
HKU820-T19R ...	19	117	25 30 35 40 45	1" 1-1/4"	1-1/2"
HKU820-T21R ...	21	129	25 30 35 40 45	1" 1-1/4"	1-1/2"
HKU820-T23R ...	23	142	25 30 35 40 45	1" 1-1/4"	1-1/2"
HKU820-T25R ...	25	154	25 30 35 40 45	1" 1-1/4"	1-1/2"
HKU820-T27R ...	27	166	25 30 35 40 45	1" 1-1/4"	1-1/2"

Note: 1.Sprocket is used to H820 chain
2.Sprocket material: NYLON

HKS820

Plastic sprockets

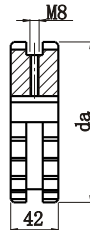
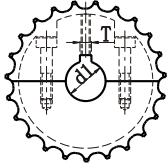

Unit:mm

Chain code	Tooth number Z	Excircle diameter da	Center bore		
			d-Metric	d-Inch	d-Inch
HKS820-T17R ...	17	105	25 30 35 40 45	1" 1-1/4"	1-1/2"
HKS820-T19R ...	19	117	25 30 35 40 45	1" 1-1/4"	1-1/2"
HKS820-T21R ...	21	129	25 30 35 40 45	1" 1-1/4"	1-1/2"
HKS820-T23R ...	23	142	25 30 35 40 45	1" 1-1/4"	1-1/2"
HKS820-T25R ...	25	154	25 30 35 40 45	1" 1-1/4"	1-1/2"
HKS820-T27R ...	27	166	25 30 35 40 45	1" 1-1/4"	1-1/2"

Note: 1. Sprocket is used to H820 chain
2.Sprocket material: NYLON

HNS820

Plastic sprockets

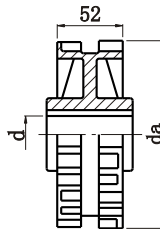

Unit:mm

Chain code	Tooth number Z	Excircle diameter da	Center bore		
			d-Metric	d-Inch	d-Inch
HNS820-T21R ...	21	129	25 30 35 40 45	1" 1-1/4"	1-1/2"
HNS820-T23R ...	23	142	25 30 35 40 45	1" 1-1/4"	1-1/2"
HNS820-T25R ...	25	154	25 30 35 40 45	1" 1-1/4"	1-1/2"

Note: 1.Sprocket is used to H820 chain
2.Sprocket material: NYLON

HKU821

Plastic sprockets

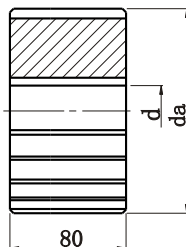

Unit:mm

Chain code	Tooth number Z	Excircle diameter da	Center bore		
			d-Metric	d-Inch	d-Inch
HKU821-T21R ...	21	129	25 30 35 40 45	1" 1-1/4"	1-1/2"
HKU821-T23R ...	23	142	25 30 35 40 45	1" 1-1/4"	1-1/2"
HKU821-T25R ...	25	154	25 30 35 40 45	1" 1-1/4"	1-1/2"

Note: 1.Sprocket is used to H820, HBP821, HBP821, HS802 chain
2.Sprocket material: NYLON



Driving Sprocket

HKS880

Plastic sprockets

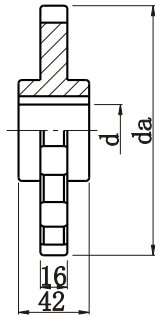

Chain code	Tooth number Z	Excircle diameter da	Unit:mm						
			Center bore		d-Metric	d-Inch			
			25	30			35	40	45
HKS880-T10R ...	10	122	25	30	35	40	45	1" 1-1/4"	1-1/2"
HKS880-T11R ...	11	135	25	30	35	40	45	1" 1-1/4"	1-1/2"

Note:1.Sprocket is used to H880, H880BO, H880TAB, H880TABO chain
2.Sprocket material: NYLON

HN880

Plastic sprockets

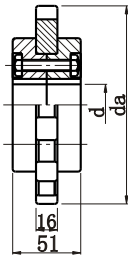

Chain code	Tooth number Z	Excircle diameter da	Unit:mm						
			Center bore		d-Metric	d-Inch			
			25	30			35	40	45
HN880-T12R ...	12	147	25	30	35	40	45	1" 1-1/4"	1-1/2"

Note:1.Sprocket is used to H880, H880BO, H880TAB, H880TABO chain
2.Sprocket material: NYLON

HNS880

Plastic sprockets

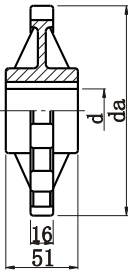

Chain code	Tooth number Z	Excircle diameter da	Unit:mm						
			Center bore		d-Metric	d-Inch			
			25	30			35	40	45
HNS880-T10R ...	10	122	25	30	35	40	45	1" 1-1/4"	1-1/2"
HNS880-T12R ...	12	147	25	30	35	40	45	1" 1-1/4"	1-1/2"

Note:1.Sprocket is used to H880, H880BO, H880TAB, H880TABO chain
2.Sprocket material: NYLON

HKU880

Plastic sprockets

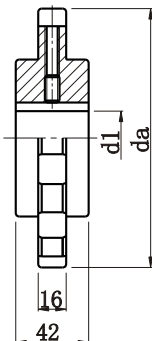

Chain code	Tooth number Z	Excircle diameter da	Unit:mm						
			Center bore		d-Metric	d-Inch			
			25	30			35	40	45
HKU880-T10R ...	10	122	25	30	35	40	45	1" 1-1/4"	1-1/2"
HKU880-T11R ...	11	135	25	30	35	40	45	1" 1-1/4"	1-1/2"
HKU880-T12R ...	12	147	25	30	35	40	45	1" 1-1/4"	1-1/2"

Note:1.Sprocket is used to H880, H880BO, H880TAB, H880TABO chain
2.Sprocket material: NYLON

HNS880S

Sprockets

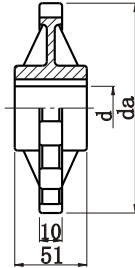

Unit:mm

Chain code	Tooth number Z	Excircle diameter da	Center bore	
			d- Metric	d- Inch
HNS880S-T10R ...	10	122	25 30 35 40 45	1" 1-1/4" 1-1/2"
HNS880S-T12R ...	12	147	25 30 35 40 45	1" 1-1/4" 1-1/2"
HNS880S-T12R ...	12	147	25 30 35 40 45	1" 1-1/4" 1-1/2"

Note:1.Sprocket is used to H880TABO chain
2.Sprocket material: NYLON

HKU882

Plastic sprockets

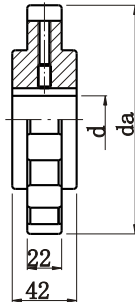

Unit:mm

Chain code	Tooth number Z	Excircle diameter da	Center bore	
			d- Metric	d- Inch
HKU882-T10R ...	10	125	25 30 35 40 45	1" 1-1/4" 1-1/2"
HKU882-T11R ...	11	137	25 30 35 40 45	1" 1-1/4" 1-1/2"
HKU882-T12R ...	12	150	25 30 35 40 45	1" 1-1/4" 1-1/2"

Note:1.Sprocket is used to H882, H882TAB, H882TABF, H882GD, H882GJ, HRR882TAB, HBP1882, HBP882, HBP882TAB, HBP882TABF, HBP883TAB chain
2.Sprocket material: NYLON

HKS882

Plastic sprockets

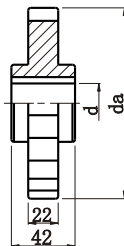

Unit:mm

Chain code	Tooth number Z	Excircle diameter da	Center bore	
			d- Metric	d- Inch
HKS882-T10R ...	10	125	25 30 35 40 45	1" 1-1/4" 1-1/2"
HKS882-T11R ...	11	137	25 30 35 40 45	1" 1-1/4" 1-1/2"

Note:1.Sprocket is used to H882, H882TAB, H882TABF, H882GD, H882GJ, HRR882TAB, HBP1882, HBP882, HBP882TAB, HBP882TABF, HBP883TAB chain
2.Sprocket material: NYLON



Driving Sprocket

HN882

Sprockets

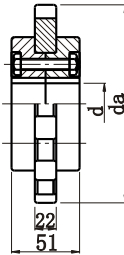

Unit:mm

Chain code	Tooth number Z	Excircle diameter da	Center bore			
			d-Metric	d-Inch		
HN882-T12R...	12	150	25 30 35 40 45	1"	1-1/4"	1-1/2"

Note:1.Sprocket is used to H882, H882TAB, H882TABF, H882GD, H882GJ, HRR882TAB, HBP1882, HBP882, HBP882TAB, HBP882TABF, HBP883TAB chain
2.Sprocket material: NYLON

HNS882

Sprockets

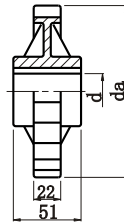

Unit:mm

Chain code	Tooth number Z	Excircle diameter da	Center bore			
			d-Metric	d-Inch		
HNS882-T12R ...	12	150	25 30 35 40 45	1"	1-1/4"	1-1/2"

Note:1.Sprocket is used to H882, H882TAB, H882TABF, H882GD, H882GJ, HRR882TAB, HBP1882, HBP882, HBP882TAB, HBP882TABF, HBP883TAB chain
2.Sprocket material: NYLON

HKU881

Sprockets

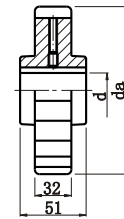

Unit:mm

Chain code	Tooth number Z	Excircle diameter da	Center bore			
			d-Metric	d-Inch		
HKU881-T21R ...	21	129	25 30 35 40 45	1"	1-1/4"	1-1/2"
HKU881-T23R ...	23	142	25 30 35 40 45	1"	1-1/4"	1-1/2"
HKU881-T25R ...	25	154	25 30 35 40 45	1"	1-1/4"	1-1/2"

Note:1.Sprocket is used to HS881,HS881Z,HS881TAB,HS881TABZ chain
2.Sprocket material: NYLON

HNS881

Sprockets

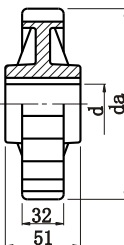

Unit:mm

Chain code	Tooth number Z	Excircle diameter da	Center bore			
			d-Metric	d-Inch		
HNS881-T21R ...	21	129	25 30 35 40 45	1"	1-1/4"	1-1/2"
HNS881-T23R ...	23	142	25 30 35 40 45	1"	1-1/4"	1-1/2"
HNS881-T25R ...	25	154	25 30 35 40 45	1"	1-1/4"	1-1/2"

Note:1.Sprocket is used to HS881,HS881Z,HS881TAB,HS881TABZ chain
2.Sprocket material: NYLON

HKU1700

Sprockets

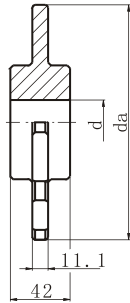

Unit:mm

Chain code	Tooth number Z	Excircle diameter da	Center bore	
			d-Metric	d-Inch
HKU1700-T8R ...	8	136	25 30 35 40 45	1" 1-1/4" 1-1/2"
HKU1700-T10R ...	10	165	25 30 35 40 45	1" 1-1/4" 1-1/2"
HKU1700-T13R ...	13	215	25 30 35 40 45	1" 1-1/4" 1-1/2"

Note: 1.Sprocket is used to H1701, H1702, H1702TAB, H1700R, H1700K chain
2.Sprocket material: NYLON

HN1700

Sprockets

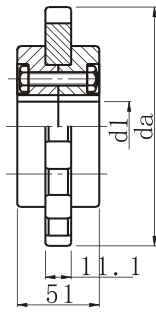

Unit:mm

Chain code	Tooth number Z	Excircle diameter da	Center bore	
			d-Metric	d-Inch
HN1700-T10R ...	10	165	25 30 35 40 45	1" 1-1/4" 1-1/2"
HN1700-T8R ...	8	136	25 30 35 40 45	1" 1-1/4" 1-1/2"

Note: 1.Sprocket is used to H1701, H1702, H1702TAB, H1700R, H1700K chain
2.Sprocket material: NYLON

HKU600

Sprockets

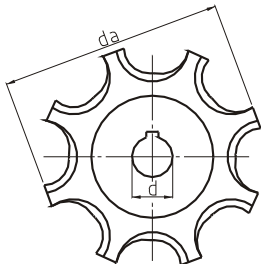

Unit:mm

Chain code	Tooth number Z	Excircle diameter da	Center bore	
			d-Metric	d-Inch
HKUA600-T6R ...	6	127	25 30 35 40 45	1" 1-1/4" 1-1/2"
HKUA600-T8R ...	8	166	25 30 35 40 45	1" 1-1/4" 1-1/2"
HKUA600-T13R ...	10	205	25 30 35 40 45	1" 1-1/4" 1-1/2"

Note: 1.Sprocket is used to HA600, HA600TAB chain
2.Sprocket material: NYLON

HKUA1400

Sprockets

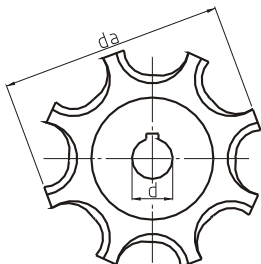

Unit:mm

Chain code	Tooth number Z	Excircle diameter da	Center bore	
			d-Metric	d-Inch
HKUA1400-T10R ...	10	267	25 30 35 40 45	1" 1-1/4" 1-1/2"

Note: 1.Sprocket is used to HA1400, HA1400TAB chain
2.Sprocket material: NYLON



Passive sprocket

HXT820 Straight chain passive sprocket

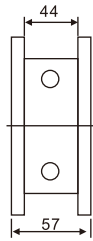
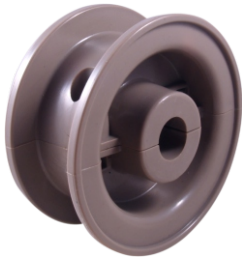

Unit:mm

Chain code	Tooth number Z	Excircle diameter da	Center bore	
			d-Metric	d-Inch
HXT820-T17R ...	17	106.5	25 30	1" 1-1/4" 1-1/2"
HXT820-T19R ...	19	118	25 30 35 40	1" 1-1/4" 1-1/2"
HXT820-T21R ...	21	129	25 30 35 40	1" 1-1/4" 1-1/2"
HXT820-T23R ...	23	142	25 30 35 40 45	1" 1-1/4" 1-1/2"
HXT820-T25R ...	25	154	25 30 35 40 45	1" 1-1/4" 1-1/2"

Note: 1. Sprocket is used to H820, H815, H815Z, H812, H881M chain
2. Sprocket material: NYLON

HXT820-1 Straight chain passive sprocket

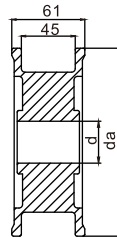

Unit:mm

Chain code	Tooth number Z	Excircle diameter da	Center bore	
			d-Metric	d-Inch
HXT820-T17R ...	17	106.5	25 30	1" 1-1/4" 1-1/2"
HXT820-T19R ...	19	118	25 30 35 40	1" 1-1/4" 1-1/2"
HXT820-T21R ...	21	129	25 30 35 40	1" 1-1/4" 1-1/2"
HXT820-T23R ...	23	142	25 30 35 40 45	1" 1-1/4" 1-1/2"
HXT820-T25R ...	25	154	25 30 35 40 45	1" 1-1/4" 1-1/2"

Note: 1. Sprocket is used to H820, H815, H815Z, H812, H881M chain
2. Sprocket material: NYLON

HXT880TAB Plastic passive sprocket

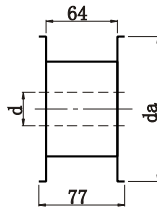

Unit:mm

Chain code	Tooth number Z	Excircle diameter da	Center bore	
			d-Metric	d-Inch
HXT880TAB-T10R ...	10	129	25 30 35 40 45	1" 1-1/4" 1-1/2"
HXT880TAB-T11R ...	11	142	25 30 35 40 45	1" 1-1/4" 1-1/2"
HXT880TAB-T12R ...	12	154	25 30 35 40 45	1" 1-1/4" 1-1/2"

Note: 1. Sprocket is used to H880, H880BO, H880TAB, H882TABO chain
2. Sprocket material: NYLON

HXS882 Plastic passive sprocket

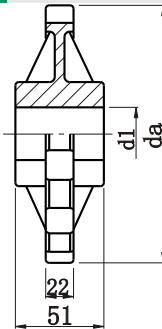

Unit:mm

Chain code	Tooth number Z	Excircle diameter da	Center bore	
			d-Metric	d-Inch
HXS882-T10R ...	10	122	25 30 35 40 45	1" 1-1/4" 1-1/2"
HXS882-T12R ...	12	147	25 30 35 40 45	1" 1-1/4" 1-1/2"

Note: 1. Sprocket is used to H882, H882BO, H882TAB, H882TABO chain
2. Sprocket material: NYLON

HXK882 Plastic passive sprocket

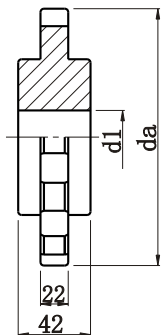

Unit:mm

Chain code	Tooth number Z	Excircle diameter da	Center bore	
			d-Metric	d-Inch
HXK882-T10R ...	10	122	25 30 35 40 45	1" 1-1/4" 1-1/2"
HXK882-T11R ...	11	135	25 30 35 40 45	1" 1-1/4" 1-1/2"
HXK882-T12R ...	12	147	25 30 35 40 45	1" 1-1/4" 1-1/2"

Note: 1. Sprocket is used to H882, H882BO, H882TAB, H882TABO chain
2. Sprocket material: NYLON

HXS880

Plastic passive sprocket

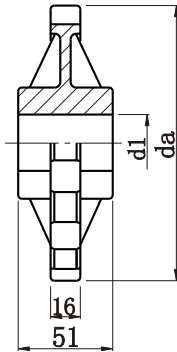

Chain code	Tooth number Z	Excircle diameter da	Center bore		
			d-Metric	d-Inch	d-Inch
HXS880-T10R ...	10	122	25 30 35 40 45	1" 1-1/4"	1-1/2"
HXS880-T12R ...	12	147	25 30 35 40 45	1" 1-1/4"	1-1/2"

Note: 1. Sprocket is used to H880, H880BO, H880TAB, H880TABO chain
2. Sprocket material: NYLON

HXK880

Plastic passive sprocket

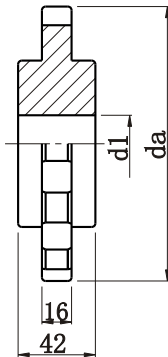

Chain code	Tooth number Z	Excircle diameter da	Center bore		
			d-Metric	d-Inch	d-Inch
HXK880-T10R ...	10	122	25 30 35 40 45	1" 1-1/4"	1-1/2"
HXK880-T11R ...	11	135	25 30 35 40 45	1" 1-1/4"	1-1/2"
HXK880-T12R ...	12	147	25 30 35 40 45	1" 1-1/4"	1-1/2"

Note: 1. Sprocket is used to H880, H880BO, H880TAB, H880TABO chain
2. Sprocket material: NYLON

HXS881

Plastic passive sprocket

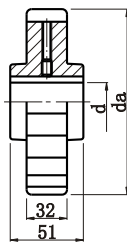

Chain code	Tooth number Z	Excircle diameter da	Center bore		
			d-Metric	d-Inch	d-Inch
HXS881-T21R ...	21	129	25 30 35 40 45	1" 1-1/4"	1-1/2"
HXS881-T23R ...	23	142	25 30 35 40 45	1" 1-1/4"	1-1/2"
HXS881-T25R ...	25	154	25 30 35 40 45	1" 1-1/4"	1-1/2"

Note: 1. Sprocket is used to H881, HS881Z, HS881TAB, HS881TABZ chain
2. Sprocket material: NYLON

HXK881

Plastic passive sprocket

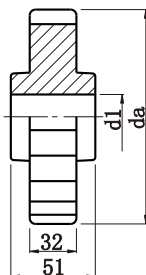

Chain code	Tooth number Z	Excircle diameter da	Center bore		
			d-Metric	d-Inch	d-Inch
HXK881-T21R ...	21	129	25 30 35 40 45	1" 1-1/4"	1-1/2"
HXK881-T23R ...	23	142	25 30 35 40 45	1" 1-1/4"	1-1/2"
HXK881-T25R ...	25	154	25 30 35 40 45	1" 1-1/4"	1-1/2"

Note: 1. Sprocket is used to H881, HS881Z, HS881TAB, HS881TABZ chain
2. Sprocket material: NYLON



Passive sprocket

H1100

Plastic sprockets



Chain code	Tooth number Z	Center bore da	Center bore d (□)	Unit:mm
				Applicable chain
H1100T18	18	89	25 30 35 40	H1100
H1100T24	24	117	25 30 35 40	H1100
H1100T32	32	155	25 30 35 40	H1100

H1100

Plastic sprockets



Chain code	Tooth number Z	Center bore da	Center bore d (□)	Unit:mm
				Applicable chain
H1100T24	24	117	25 30 35 40	H1100
H1100T32	32	155	25 30 35 40	H1100

H3110

Plastic sprockets

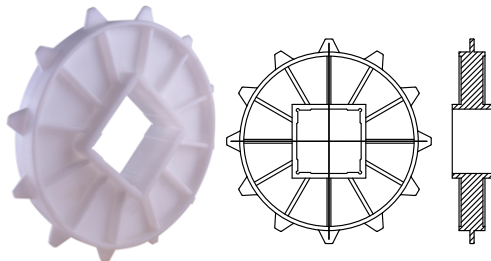

Chain code	Tooth number Z	Center bore da	Center bore d (□)	Unit:mm
				Applicable chain
H3110T12	12	197	60	H3100

H5935\H5936

Plastic sprockets

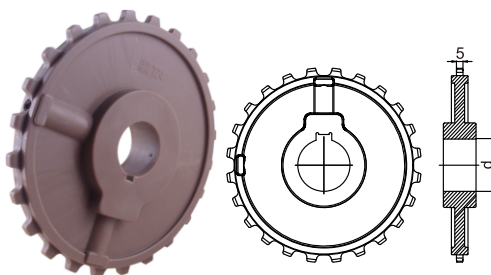

Chain code	Tooth number Z	Center bore da	Center bore d (□)	Unit:mm
				Applicable chain
H5935T24	24	181	25 30 35 40	H5935
H5936T24	24	181	25 30 35 40	H5936

H2200

Plastic sprockets

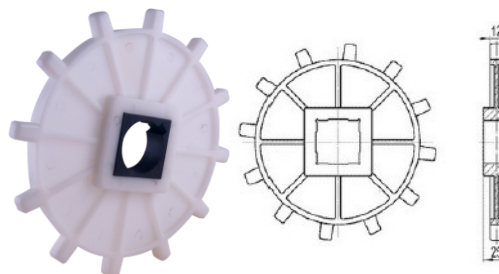

Chain code	Tooth number Z	Center bore da	Center bore d (□)	Unit:mm
				Applicable chain
H2200T12	12	181	25 30 35 40	H2200

H3110

Plastic sprockets

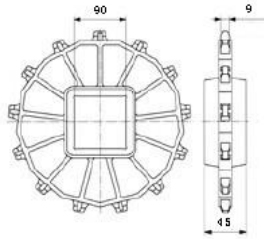

Chain code	Tooth number Z	Center bore da	Center bore d (□)	Unit:mm	
				Applicable chain	Materials
H3110T16	12	261	90	H3110	POM

H1600

Plastic sprockets

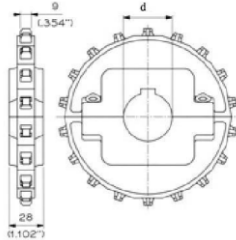

Chain code	Tooth number Z	Center bore da	Center bore d (□)	Unit:mm	
				Applicable chain	Materials
H1600T16	16	130.2	25 30 35 40	H1600	PA

HJ2075

Nozzles

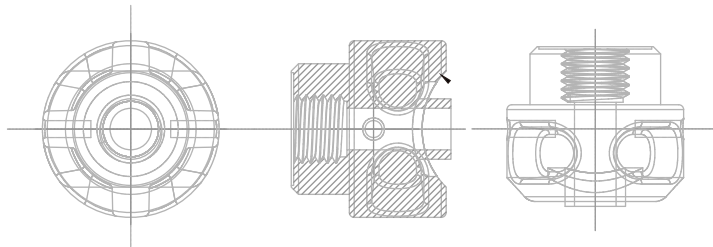
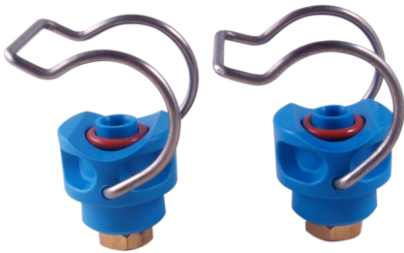

HJ2076

Nozzles

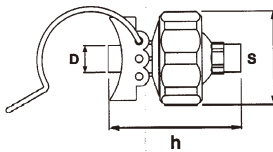

Chain code	Size	Outside diameter	External dimension			Weight
			h	s	D	
			Length/Body	Opposite side length	Pipe opening diameter	PP
HJ2076	1 / 2	20-22	62.8	42	D14	70
HJ2076	3 / 4	25-28	62.8	42	D14	70
HJ2076	1	32-35	62.8	42	D14	70
HJ2076	1-1/4	38-43	62.8	42	D16	70
HJ2076	1-1/2	44-51	62.8	42	D14/D16/D20	70
HJ2076	2	54-60	62.8	42	D14	70

HJ20751

Nozzles

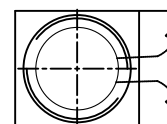
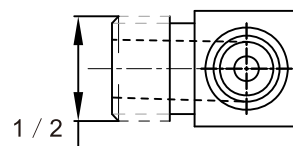
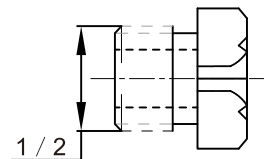
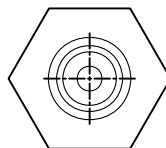



Passive sprocket

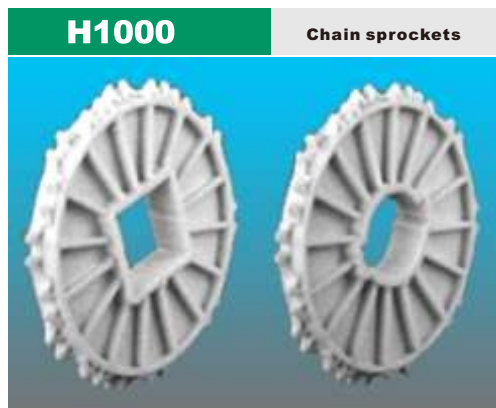

Unit:mm

Chain code	Tooth number Z	Center bore da	Center bore d(□)	Applicable chain	Materials
H1000T12R□...	12	98	30 40 50	H1000series mesh chain	NYLON
H1000T18R□...	18	146	30 40 50 65	H1000series mesh chain	NYLON
H1000T20R□...	20	162	30 40 50 65	H1000series mesh chain	NYLON
H5935T10R□...	10	62	20 25	H5935series mesh chain	NYLON
H5935T24R□...	24	147	30 35 40	H5935series mesh chain	NYLON
H5935T31R□...	31	190	35 40 45 50 55 60	H5935series mesh chain	NYLON
H900T6□...	6	53	25	H900 series mesh chain	NYLON
H900T9□...	9	79	30 35 40	H900 series mesh chain	NYLON
H900T10□...	10	89	30 35 40 45	H900 series mesh chain	NYLON
H900T12□...	12	104	30 35 40 45	H900 series mesh chain	NYLON
H900T15□...	15	130	30 35 40 45 50	H900 series mesh chain	NYLON
H900T18□...	18	155	30 35 40 45 50 55 60	H900 series mesh chain	NYLON
H900T20□...	20	173	30 35 40 45 50 55 60	H900 series mesh chain	NYLON

H100T16 Finger transfer plates 148X16T

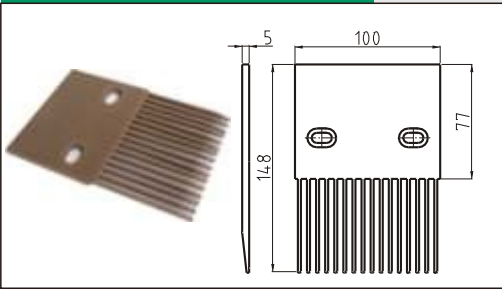

H1600RR7-1 Finger transfer plates
Narrow RR900T7-2 Finger transfer plates 152x5T/7T

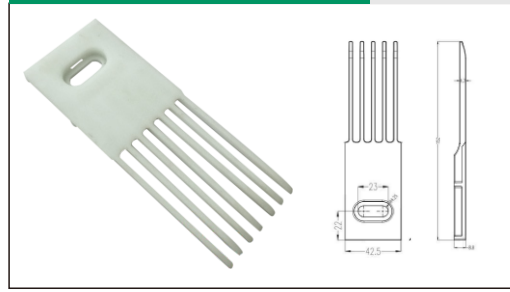

H900 Finger transfer plates 165X18T

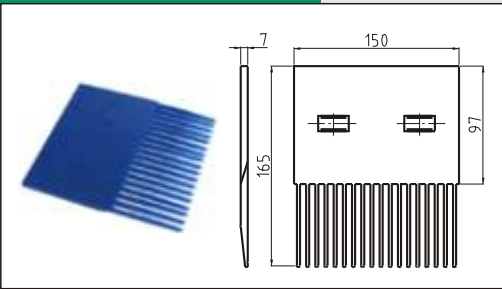

H3110T24 Finger transfer plates 190X24T

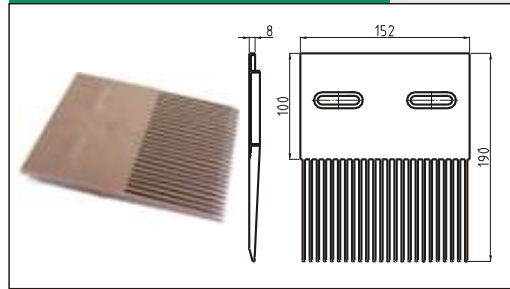

H4707ST12-1 Finger transfer plates 197X12T

H4707ST12-2 Finger transfer plates 218X12T

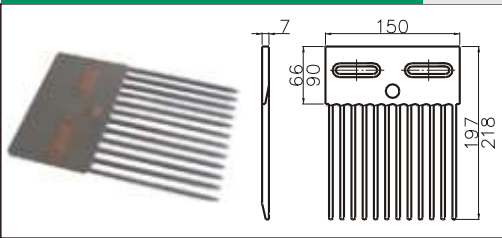

H2004T24 Finger transfer plates 135X24T

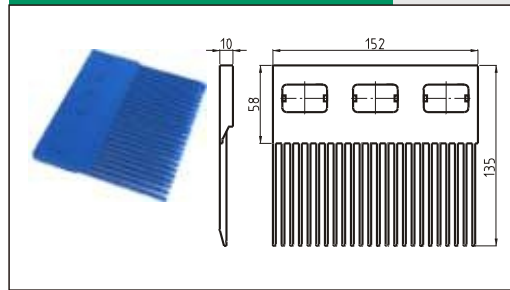

H4707RT12 Finger transfer plates 190X12T

H5997T12 Finger transfer plates 190X12T

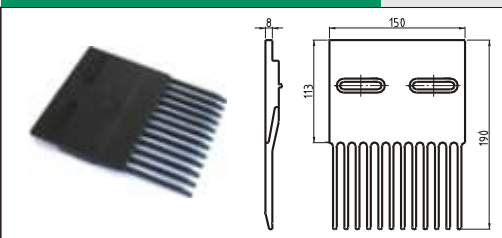

H4803T32 Finger transfer plates 152X32T

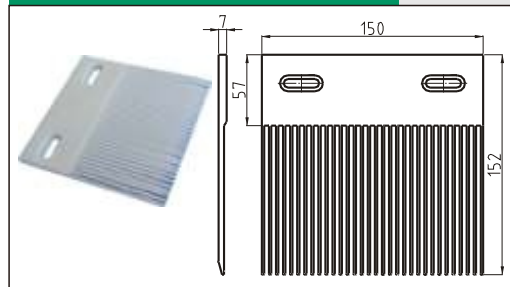

H5937T15 Finger transfer plates 148X15T

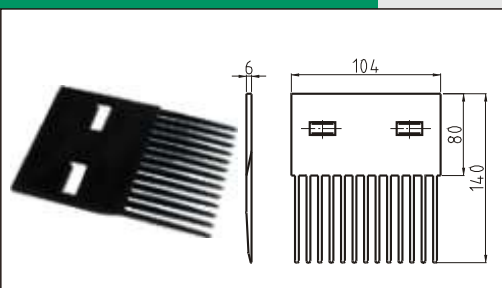

H2037T28 Finger transfer plates 215X28T

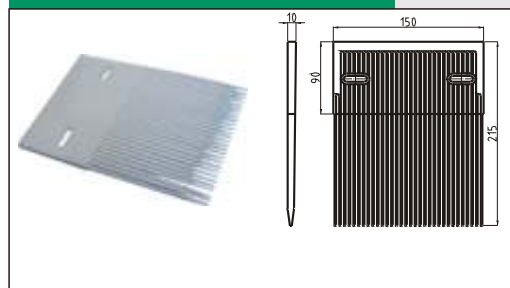



Link code

H174

Cross clamp A

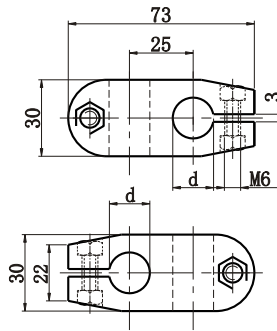

d	Order number
12	H174-12
14	H174-14
15	H174-15
16	H174-16
18	H174-18

Material: joint-POLY Bolt、nut-S.S

H340

Cross clamp B

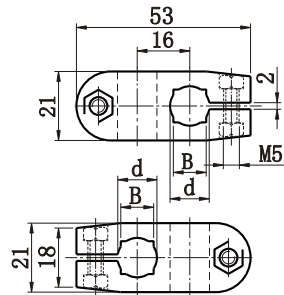

d	B	Order number
10	8	H340-10
12	10	H340-12
14	12	H340-14

Material: joint-POLY Bolt、nut-S.S

H341

Clamp A

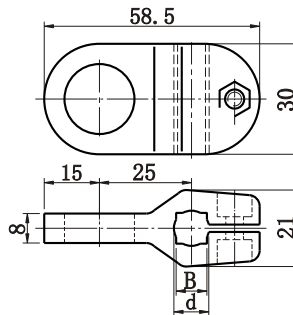

d	B	Order number
10	8	H341-10
12	10	H341-12
14	12	H341-14

Material: clamp-POLY Bolt、nut-S.S

H339

Clamp A

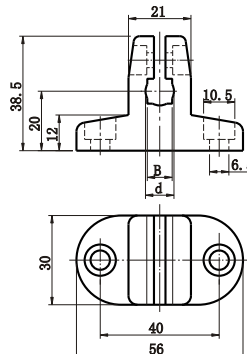

d	B	Order number
10	8	H339-10
12	10	H339-12
14	12	H339-14

Material: clamps-POLY Bolt、nut-S.S



H587A

Cross clamp for circular

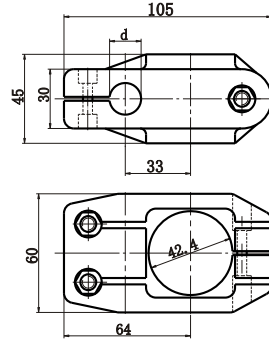

d	Order number
16	H587A-16
18	H587A-18
20	H587A-20

Material:joint-POLY
Bolt、nut-S.S

H587B

Cross clamp for square

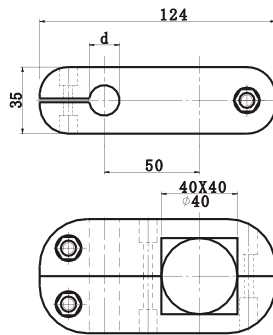

d	Order number
16	H587B-16
18	H587B-18
20	H587B-20

Material:joint-POLY
Bolt、nut-S.S

H518

Cross contact lever for sensor

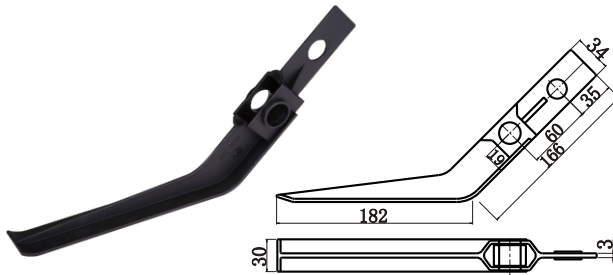

Depending on the control contact lever of type and a variety of channels,lever has three forms:

- 518A Pass type
- 518B Induction type
- 518C Anapsid

Material:lever-POLY
Center set-S. S

H343D

Pipe plug



d	Order number
10	H343D-10
12	H343D-12
14	H343D-14
18	H343D-18
48	H343D-48

Material:Plug-POLY

H343E

Square plug

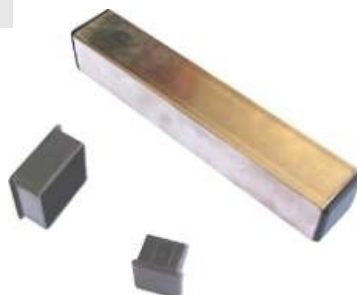

d	Order number
30	H343E-30
40	H343E-40
50	H343E-50

Material:Plug-POLY



Guide rail bracket

H257

Guide rail bracket A

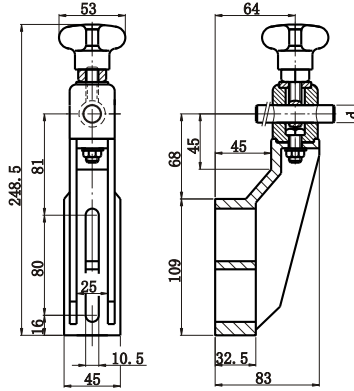

d	Order number
12	H257-12
14	H257-14
16	H257-16

Material: Bracket-POLY
Bolt、nut-S.S

H107

Guide rail bracket C

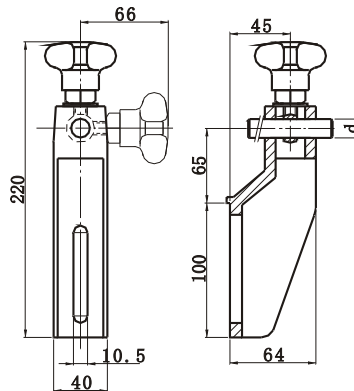

d	Order number
12	H107-12
14	H107-14
16	H107-16

Material: Bracket-POLY
Bolt、nut-S.S

H617

Guide rail bracket D

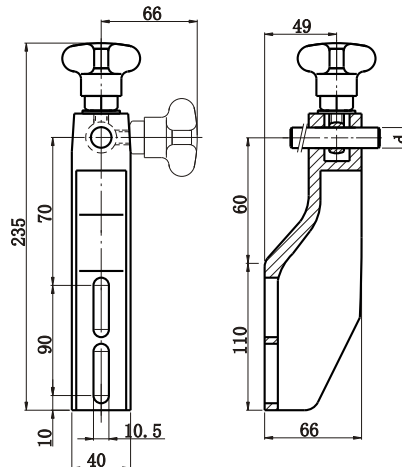

d	Order number
12	H617-12
14	H617-14
16	H617-16

Material: Bracket-POLY
Bolt、nut-S.S

H182A

Thread knob

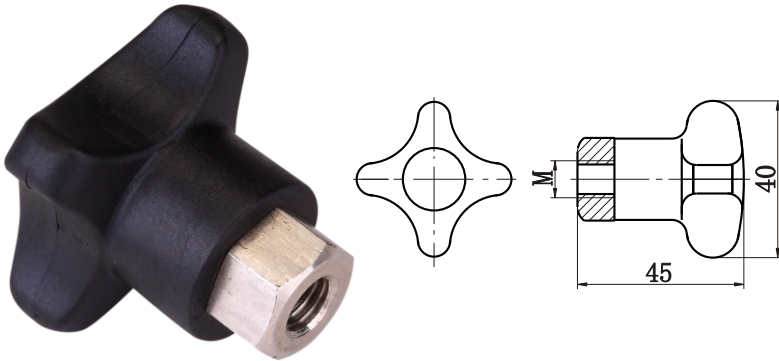

M	Order number
6	H182A-6
8	H182A-8
10	H182A-10

Material: star knob-POLY
Spindle nut-S.S

H185A

Thread knob

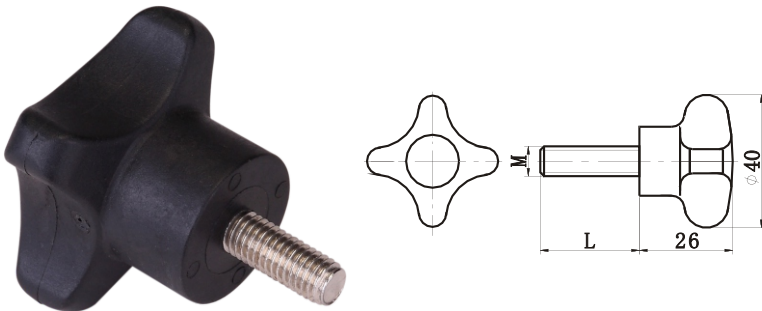

M	L	Order number
6	8	H185A-6X8
6	14	H185A-6X14
8	10	H185A-8X10
8	16	H185A-8X16
10	12	H185A-10X12
10	18	H185A-10X18

Material: star knob-POLY
Spindle bolt-S.S

H183

Thread knob

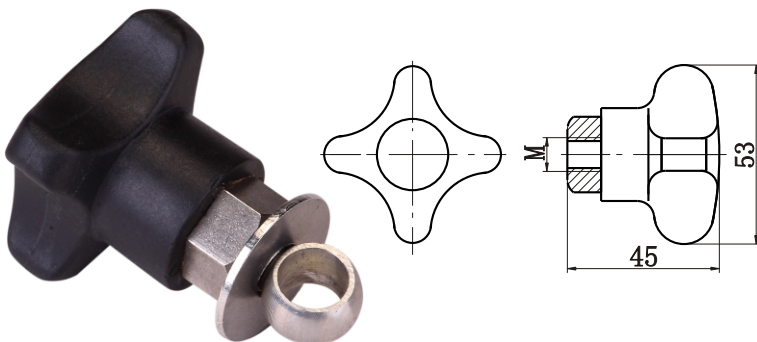

M	Order number
10	H183-10
12	H183-12

Material: star knob-POLY
Spindle bolt-S.S



Guide rail gripper

H185

Thread knob

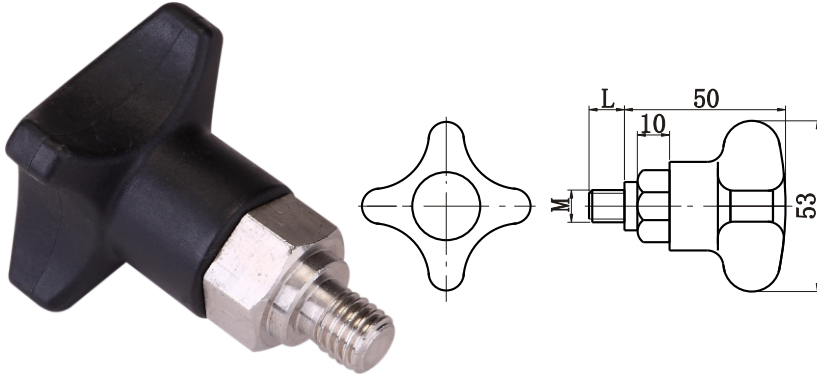

M	L	Order number
10	12	H185-10X12
10	18	H185-10X18
12	14	H185-12X14
12	20	H185-12X20

Material:star knob-POLY
Spindle bolt-S.S

H71

Rail clamp

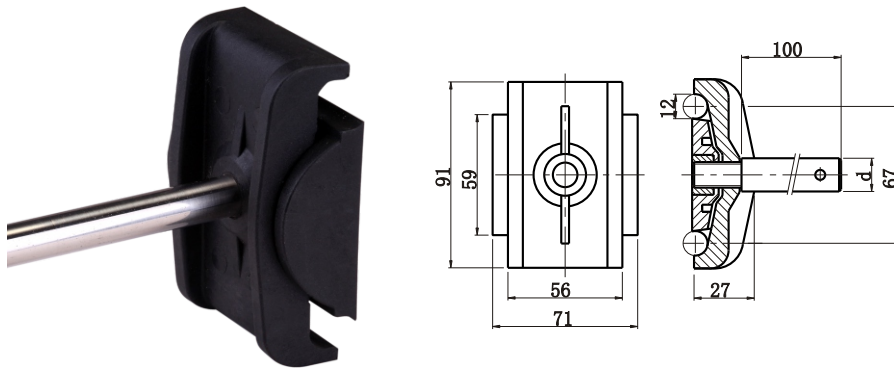

d	Order number
12	H71-12
12.7	H71-12.7
14	H71-14
16	H71-16
17	H71-17

Material:clamp-POLY
Spindle nut-S.S

H303

Handle T

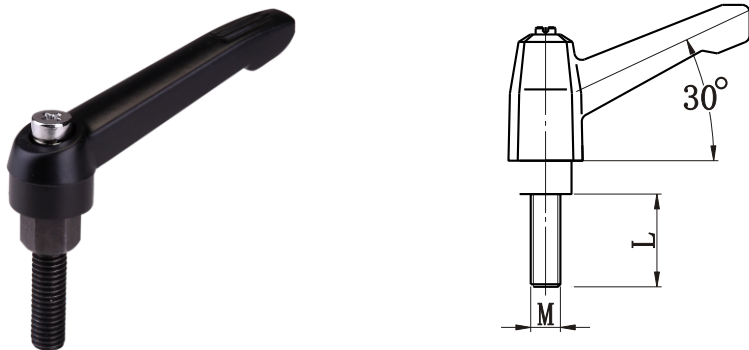

M	L	Order number
6	20	H303-6X20
8	25	H303-8X25
10	30	H303-10X30

Material:handle-POLY
Spindle nut-S.S

H182

Thread knob

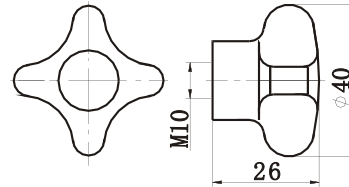
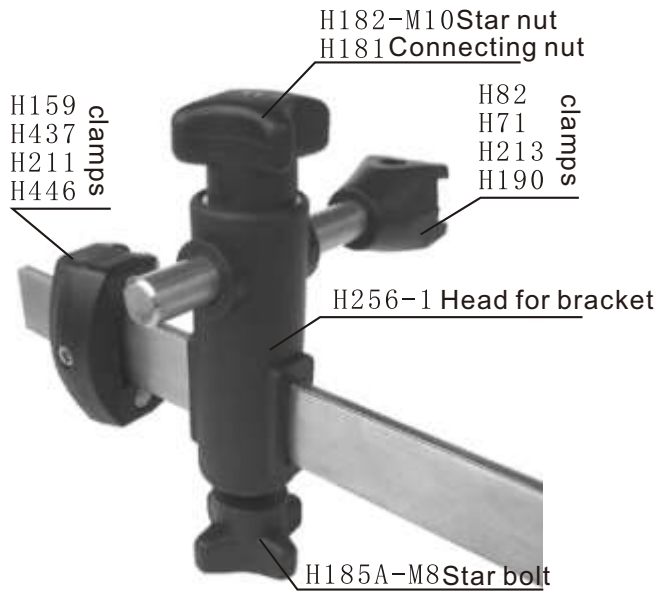

H181A

Screw

H181B

Screw

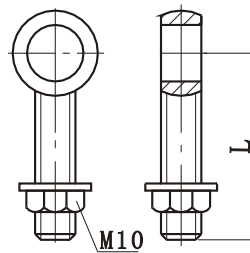

L	Order number
45	H181A
65	H181B

H256-48

Head for bracket

H256-65

Head for bracket

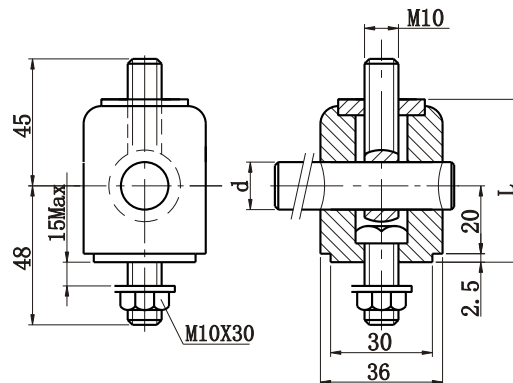

d	L	Order number
12	48	H256-48-12
14	48	H256-48-14
16	48	H256-48-16
12	65	H256-65-12
14	65	H256-65-14
16	65	H256-65-16

Material:
Head for bracket-POLY
Bolt, nut-S.S



Guard rail Bracket accessories

H255	Round screw
H359	Round screw

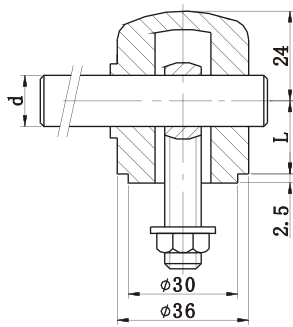
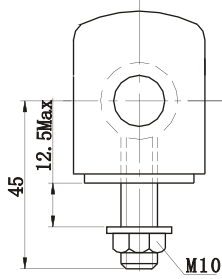

d	L	Order number
12	20	H255-12
14	20	H255-14
16	20	H255-16
12	38	H359-12
14	38	H359-14
16	38	H359-16

Material:
Dome round screw-POLY
Spindle bolt-S.S

H193	Guard rail bracket
-------------	--------------------

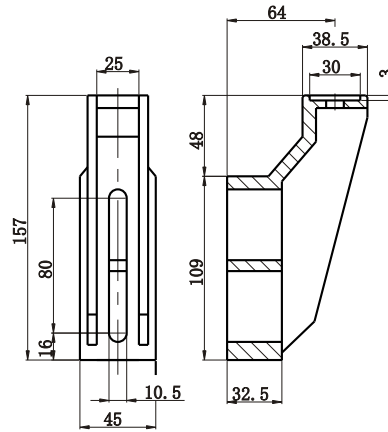

H142	Bracket spacer
-------------	----------------

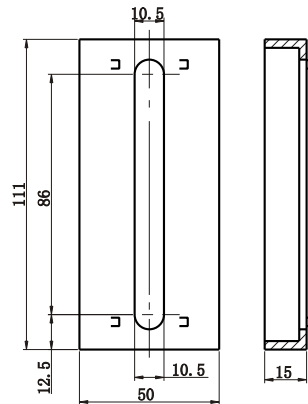

H159-12

Clamp for round tube

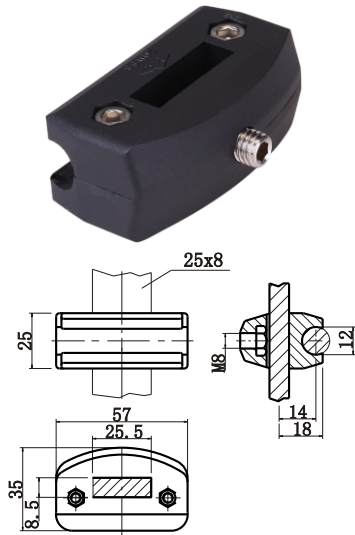

Material: Clamp-POLY
Bolt, nut-S.S

H437-12

Clamp for round

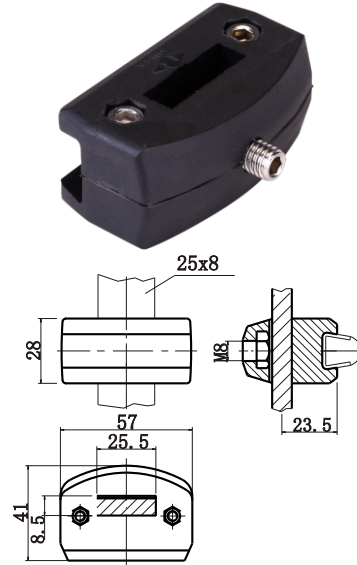

Material: Clamp-POLY
Bolt, nut-S.S

H82-12

Clamp for square

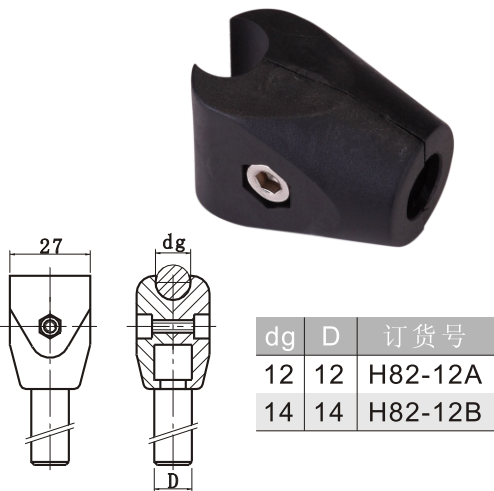

Material: Clamp-POLY
Bolt, nut-S.S

H210

Square single clamp

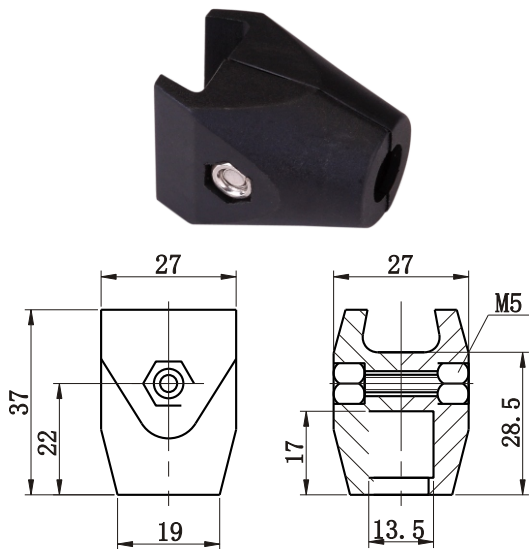

Material: Clamp-POLY
Bolt, nut-S.S



Guard rail Bracket accessories

H2011

Double clamp

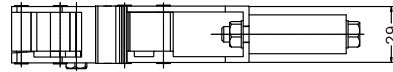
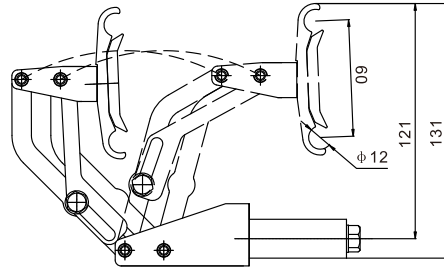

HG508A

Roller side guard rail

HG508B

Roller side guard rail

HG381

Roller side guard rail

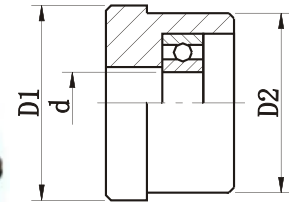

Unit:mm

Chain code	d	D1	D2	Bearing size
HG508A	12	51	48	6202Z
HG508B	17	51	48	6003Z
HG381	12	38.1	35.5	6001Z

F268

Joinball



HJ200

Leveling feet



H580-32

Roller side guard rail

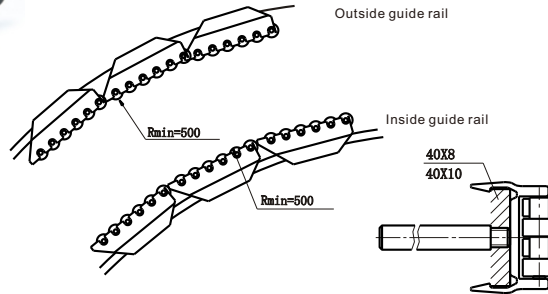
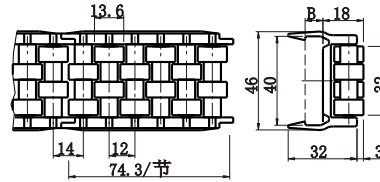

B	Order number
8	H580-32-8
10	H580-32-10

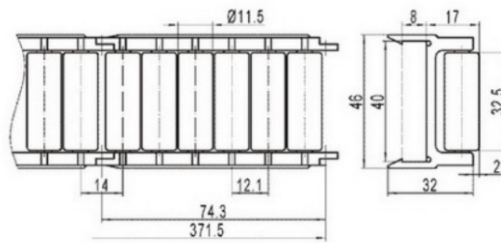

名称 Code	
单排滚珠护栏 One roller design	For 40x8 Plate

H580-64

Roller side guard rail

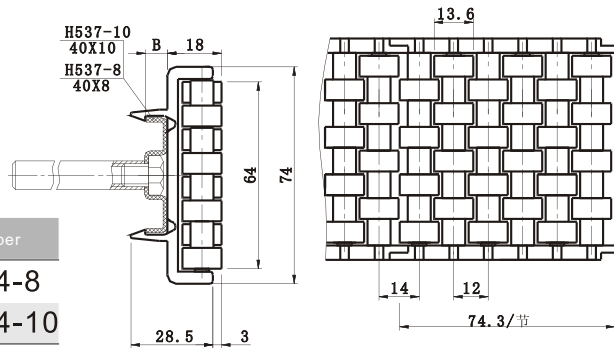

B	Order number
8	H580-64-8
10	H580-64-10

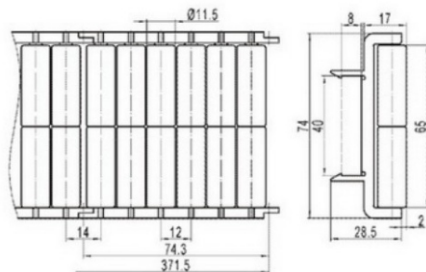

名称 Code	
双排滚珠护栏 Two roller design	For 40x8 Plate



Roller guard rail

H128-47

Roller guard rail

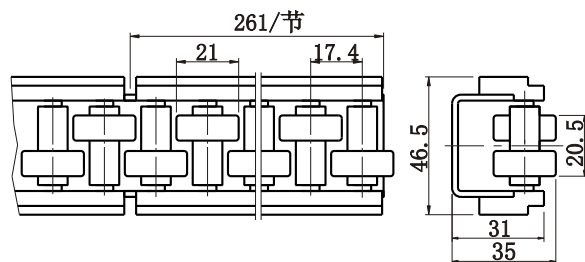

H128-73

Roller guard rail

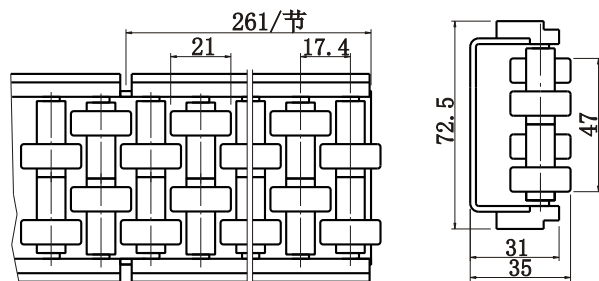
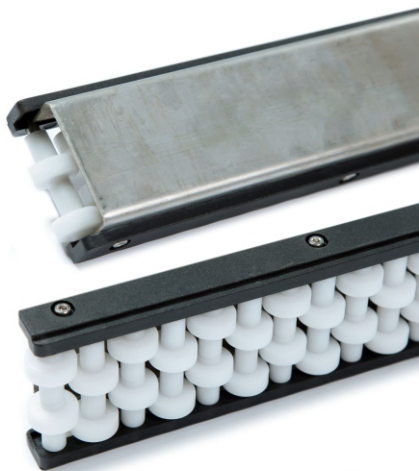

H64-0

Dynamic guard rail



H128-99

Roller guard rail

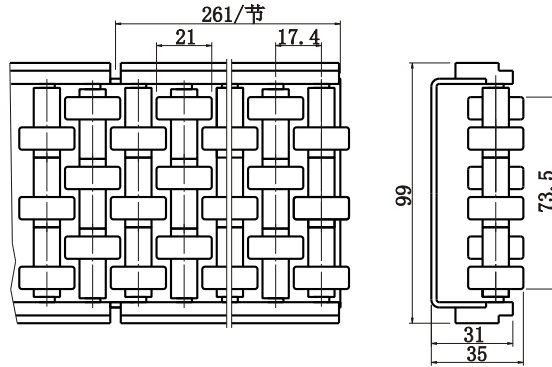
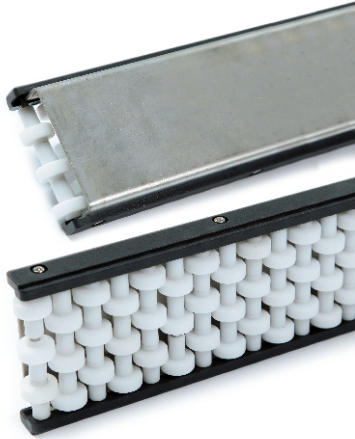

Material: Guide rail bracket-s.s; Roller POM

H128-125

Roller guard rail

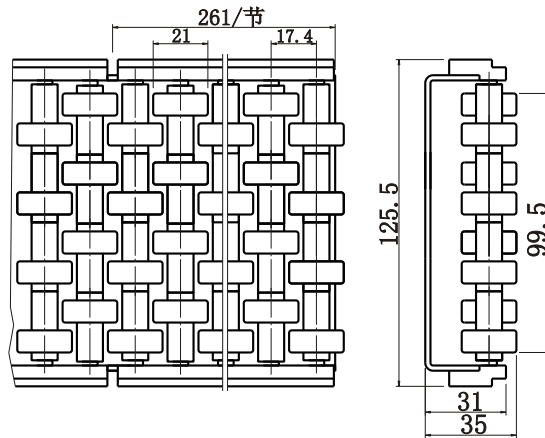
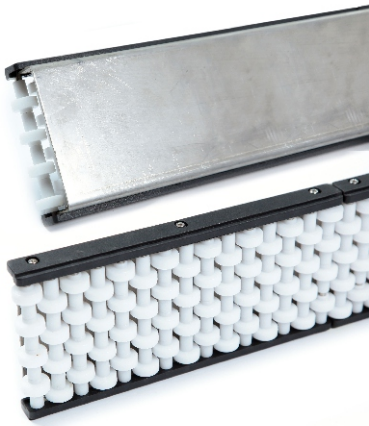

Material: Guide rail bracket-s.s; Roller POM

Guard rail accessory

H363-1

Ball bearing

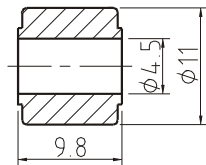

H363-3

Ball bearing

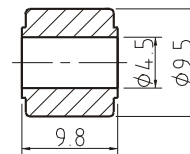



Plastic chain accessories

H567

Ball bearing transfer

85X55.5X21.4

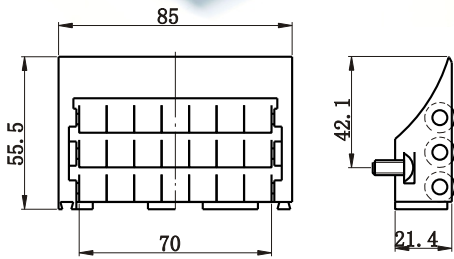

H568

Ball bearing transfer

85X55.5X21.4

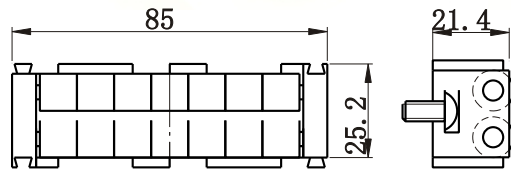
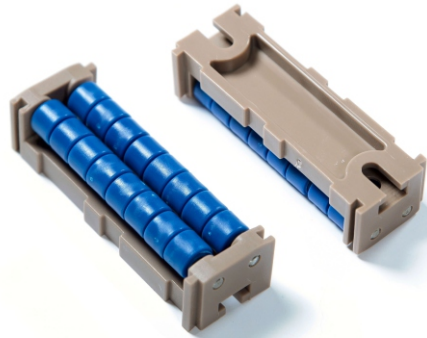

H569

Ball bearing transfer

85X36.7X21.4

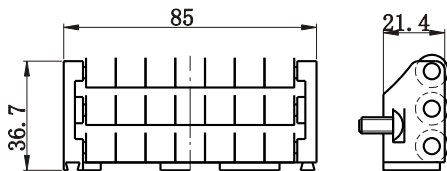

H16600

Single radius roller guide

290x31x51 Materials: POM+PP

